

OPERATION MANUAL

JENCO MODEL 6312 CTB MICROCOMPUTER BASED Conductivity/TDS & Temperature TRANSMITTER & CONTROLLER

JENCO INSTRUMENTS, INC.

7968 ARJONS DR., SUITE C
SAN DIEGO, CA 92126
TEL: (619)578-2828
FAX: (619)578-2886

JENCO ELECTRONICS, LTD.

P.O. BOX LINKOU-117
TAIPEI HSIEN, TAIWAN, R.O.C.
TEL: (886-2)2601-6191
FAX: (886-2)2601-7206

SHANGHAI JENCO ELECTRONICS, LTD.

SHANGHAI SONGJIANG SIJING TOWN
EAST ECONOMIC & TECHNOLOGY DEV. AREA (B)
SHANGHAI, CHINA
TEL: 86-21-5761-9599
FAX: 86-21-5761-9598

CONTENTS

	page
I. INITIAL INSPECTION and ASSEMBLY	3
MOUNTING PROCEDURE	3
II. GENERAL INTRODUCTION	5
III. USING THE JENCO MODEL 6308 CT	6
A.FRONT PANEL	6
B.NORMAL MODE DISPLAY	7
C.REAR CONNECTORS	8
D.TURNING ON/OFF THE INSTRUMENT	9
PROBE HANDLING AND MAINTANCE	10
STORING THE PROBE	11
IV. MODEL 6308CT MODES	11
A. NORMAL MODE	11
B. CALIBRATION/SETTING MODE	13
a.PASSWORD CHECK PAGE	14
b.USER SETTING PAGE	15
c.CONDUCTIVITY CALIBRATION PAGE	15
d.CONDUCTIVITY CONTROL SETTING PAGE	18
e.CURRENT SETTING PAGE	19
f.TEMP. CONTROL SETTING PAGE	19
V. CONTROLLING THE RELAYS	20
A. ISOLATION VOLTAGE	20
B. OUTPUT LOAD	20
C. RELAY ACTION, SETPOINT, HYSTERESIS	
MODE & HYSTERESIS VALUE	21
D.CONDUCTIVITY/TDS RELAYS	22
E.TEMPERATURE RELAY	22
VI. 4-20 mA OUTPUT	23
A.ISOLATION VOLTAGE	23
B.OUTPUT LOAD	23
C.CONDUCTIVITY OR TDS LINEAR OUTPUT	23
VII. RS485 INTERFACE OPERATION	24
A.INTRODUCTION	24
B.PREPARING THE METER	24
VIII.ERROR DISPLAYS AND TROUBLESHOOTING	25
IX. SPECIFICATION	26
X. WARRANTY	28

批注 [RL1]:

I. INITIAL INSPECTION and ASSEMBLY

批注 [RL2]:

Carefully unpack the instrument and accessories. Inspect for damages made in shipment. If any damage is found, notify your **Jenco** representative immediately. All packing materials should be saved until satisfactory operation is confirmed.

MOUNTING PROCEDURE

1. Make a cutout on any panel, with a thickness of 1/16 in. (1.5 mm) to 3/8 in. (9.5mm).
2. Remove the mounting assembly from the controller and insert the controller into the cutout.
3. Replace the mounting bracket assembly onto the controller and secure the controller to the mounting panel.

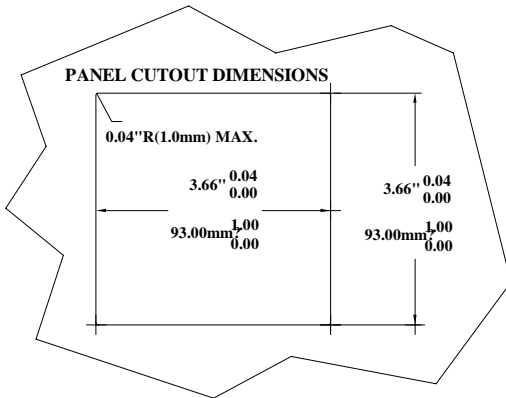

Warning:

If the equipment is used in a manner not specified by the manufacturer, the protection provided by the equipment may be impaired.

Cleaning the instrument:

1. Be sure to remove the power before attempting to clean the meter.
2. Use a lint free cloth and clean water or neutral detergent.
3. Wipe the outer surface of the instrument only.
4. Wipe-dry the instrument before powering again.

II. GENERAL INTRODUCTION

The Jenco Model 6312CTB (Conductivity and Temperature) System, is a rugged microprocessor based instrument assembled in a watertight ¼ **DIN** case, designed for use in laboratories and process control applications.

The model 6312CTB microprocessor allows the user to easily recalibrate the parameters for the probes. The Conductivity system requires only a single calibration. The microprocessor also performs a self-diagnostic routine every time you turn on the unit providing you with basic information about the stability of the instrument.

The system simultaneously displays Conductivity, Temperature, relay status and mA output in one LCD graphic screen. This system uses a two-wire or four-wire type sensor for the conductivity and a precise thermistor for temperature, providing you with accurate readings for all your measurements.

The model 6312CTB is equipped with three relays : two programmable High/Low control relays for conductivity/TDS and one programmable High/Low control relay for temperature. All relays are hysteresis driven and configurable to **CENTER** mode. The system also has an **isolated** 4-20mA analog output, offset and span configurable for Conductivity/TDS & temperature display.

The model 6312 CTB comes with a **RS485** interface which can easily let the user log all data (from multiple model 6308 or 6309) with an IBM® PC/AT compatible computer. For advanced users, the model 6308CT may also be remotely controlled from main display mode to all calibration/setting modes.

III. USING THE JENCO MODEL 6312CTB

A. FRONT PANEL

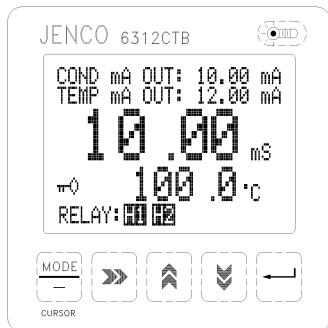

1. The [MODE/-] key.

1a. In **Normal** mode this

Key will change the display to Conductivity or TDS.

1b. In **Calibration/Setting**

mode this key will move

to the next digit of the

current active parameter.

1c. In **Calibration/Setting** mode pressing this key for 2 seconds will move you back to the previous parameter. Pressing this key for 2 seconds at the first parameter of the page will move you back to last parameter of the previous page.

2. The [CAL/VIEW] key.

2a. During any normal mode this key will switch to first Calibration/Setting screen.

2b. During Calibration/Setting mode this key will switch to the next available Calibration/Setting page pressing this key at the last User/Calibration page(TEMP. CONTROL SETTING page) will return the user to the Normal mode.

3. The [^] UP key.

During Calibration/Setting mode this key will **increment** the current blinking digit of the active parameter.

4. The [v] DOWN key.

During Calibration/Setting mode this key will **decrement** the blinking digit of the active parameter.

5. The [] **ENTER** key.

During Calibration/Setting mode this key will save the current modified parameter and move to the next parameter on the page if the parameter is the last one on the page then it will move to first parameter on the next available page.

6. The [] **LIGHT** key.

This key will turn on or turn off the backlight of the LCD. The backlight will **automatically** turn off if there is no key activity within two minutes.

7. LCD screen.

B. NORMAL MODE DISPLAY

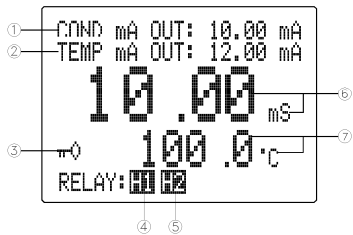

1. **COND mA OUT** -this will display the actual conductivity output of the isolated 4-20 mA output.

2. **TEMP mA OUT** - this will display the actual temperature output of the isolated 4-20 mA output.

At POWER-ON this will show "OFF" for about 3

seconds before going to normal operation. After going to the Calibration/Setting pages when the unit is not password locked this will show "FROZEN" for about 3 seconds before returning to normal operation.

3. () key icon annunciator - This will be displayed if the Calibration /Setting pages are locked, meaning the user **will not be able to** change the values unless the correct 4 digit number has been entered at the PASSWORD CHECK page.

4. **H1 or L1** annunciator - this is the status of Conductivity/TDS

Relay 1, if this is displayed then the relay is ON. (H stands for high action control and L stands for low action control)

5. **H2 or L2** annunciator - this is the status of Conductivity/TDS

Relay 2, if this is displayed then the relay is ON.

6. Conductivity or TDS display.

7. Temperature display.

C. REAR CONNECTORS

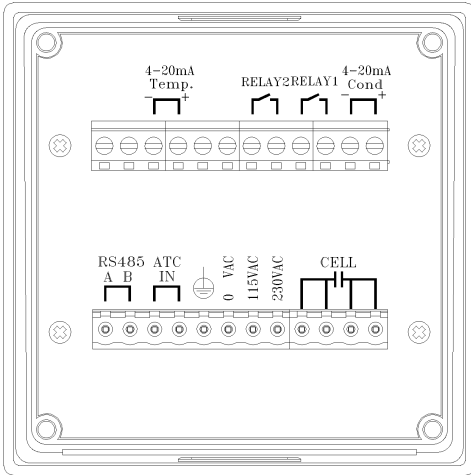

Before wiring the probes, relays, analog output, RS485 and power cord be sure that you are connecting to the right terminal as shown below (be sure the ac-plug is not plugged-in). Remember that the unit is ON once the user plugs in the power cord to an AC power supply.

1. Connect the AC line to the rear of the instrument. The model

- 6308CT can be used with 115 or 230 VAC 50/60 Hz. Power consumption is **6 watts**. Make sure the **EARTH** connector is connected to the earth lead of the AC power line.
2. Connect the proper load to the output relays. **Make sure that the load does not exceed the relay rating, 5 Amp at 115 VAC and 2.5 Amp at 230 VAC.**
 3. Set the proper load to the 4-20mA output connector. Make sure that the load impedance is less than 500 Ohms.
 4. If the user uses a two-wire conductivity probe, the user needs to short terminal D1 with terminal S1 and terminal D2 with terminal S2.

CAUTION:

MAKE SURE YOU CONNECT THE AC POWER CORD TO THE CORRECT AC TERMINALS. CONNECTING INCORRECTLY MAY DAMAGE THE UNIT PERMANENTLY.

D. TURNING ON/OFF THE INSTRUMENT

```
MODEL 6312 CTB
SELF DIAGNOSTICS
EEPROM :OK
ROM    :OK
RAM    :OK

VERSION : 1.00
```

By just plugging the unit to a correct AC voltage the unit will be ready for use. There is no Power key so unplugging and plugging the unit will turn OFF or turn ON the unit respectively. After the unit is turned on, it will perform some basic self diagnostics and will display

“OK” or “BAD”. If you received any “BAD” messages turn OFF the unit and turn it ON again. (see **VI. ERROR DISPLAYS AND TROUBLESHOOTING**).

If the message persists then you might need to call your distributor. (See **X. WARRANTY**).

After the self-diagnostic is complete the temperature will be displayed on the lowest part of the screen and you are ready to make conductivity or TDS measurements. Just immerse the probes halfway to the liquid. If possible do not allow the probes to touch any solid object in the solution. There should be no air bubbles around the probes either. Shaking or moving the probes vigorously before recording any measurement will dislodge any bubbles formed in the probes.

PROBE HANDLING AND MAINTENANCE

REMINDER: If the user uses a two-wire conductivity probe, the user needs to short terminal D1 with terminal S1 and terminal D2 with terminal S2.

Handling the probe

To ensure accurate and repeatable results:

1. The probe (cell) must be clean before making any measurements. If measuring low conductivity solutions, extra ordinary cleanliness may be necessary.
2. The probe cell plates must totally submerged in the solution. The electrode chamber must be free of trapped air or particulates. You may need to tap the probe gently to dislodge any air bubbles.
3. Ideally, the probe should be at least 1/4 inch away from any object, including the sides and bottom of the container.
4. Stirring may be necessary for high accuracy readings.
5. If possible, isolate the solution container from ground potentials.
6. Electrical fields and stray currents caused by stirrer motors, heaters, etc., can interfere with the measurements. The user should determine the effects of these and make the necessary corrections either by shielding or by disconnecting those units that cause trouble.
7. Always rinse the cell carefully before using it in another solution.
8. Never store a dirty or contaminated probe.

Storing the probe

1. Always rinse the probe thoroughly with de-ionized or clean tap water to remove contaminants before storing it.
2. For short-term storage it is recommended to immerse the probe in deionized water to keep the plates wet. For long-term storage, after rinsing the probe thoroughly, the exterior body should be wiped dry before storing it.

IV. MODEL 6312CTB MODES

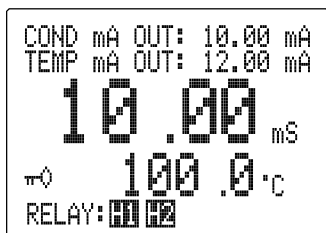

A. NORMAL MODE

Turning ON the unit will always display Conductivity in normal mode.

This instrument is designed to provide 3 distinct measurements:

1. Temperature - current temperature of the solution.
2. Compensated Conductivity - a

conductivity reading adjusted to a calculated value which would have been read if the sample had been at the user reference temperature.

The conductivity of solutions of ionic species is highly dependent on temperature, varying as much as 3% for each change of 1°C (Temperature Coefficient (TC) = 3%/°C). In addition, the temperature coefficient itself varies with the nature of the ionic species present.

Because the exact composition of a natural media is usually not known, it is best to report a conductivity at a particular temperature, e.g. 10.2 mS at 15°C. However in many cases, it is also useful to compensate for the temperature dependence in order to

determine at a glance if gross changes are occurring in the ionic content of the medium over time. For this reason, the model 6308 CT allows the user to output conductivity in either raw or compensated form. If the user Temperature Coefficient (TC) is set to 0.00% then an **uncompensated Conductivity** is output to the screen. If the TC is not zero then the Model 6308 CT uses the temperature, TC, **raw** Conductivity and the reference temperature to display the **compensated Conductivity**.

The calculation is carried out as in the equation below:

$$\text{Compensated Conductivity} = \text{Conductivity} / (1 + \text{TC} * (\text{T} - \text{RT}))$$

Where: TC = Temperature Coefficient

T= Solution temperature

RT= Reference Temperature

Note:

The TDS is based on the specific conductance reading of the solution, setting the TC to 0.00% will change the reading of conductivity to uncompensated conductivity.

3. **Total Dissolved Solid (TDS)** -

The calculation is carried out as in the equation below:

$$\text{TDS} = \text{Compensated Conductivity} * (\text{TDS Factor})$$

TDS - is an approximation of the total weight of all solids that are dissolved in a volume of water. This is expressed in **ppt** (parts per thousand also referred as g/L(gram per liter) or **ppm** (parts per million) also referred as mg/L (milligram per liter).

* In general, the total dissolved solids concentration is the sum of the cations (+charged) and anions (-charged) ions in the solution. The TDS reading provides a qualitative measure of the amount of dissolved ions, but does not tell us the nature or ion relationships.

Temperature and Conductivity (or TDS) are always simultaneously displayed in the graphic LCD screen in normal mode. You can select conductivity or TDS reading by pressing the [MODE/-] key in normal mode.

B. CALIBRATION/SETTING MODE

Pressing the [CAL/VIEW] key for about 2 seconds during normal display mode will bring-up the first page of 6 pages of the Calibration/Setting mode. Pressing [CAL/VIEW] key will switch to the next page until the last page, where pressing [CAL/VIEW] again will return the user to main display mode.

Below is a simple flowchart showing the path of the [CAL/VIEW]

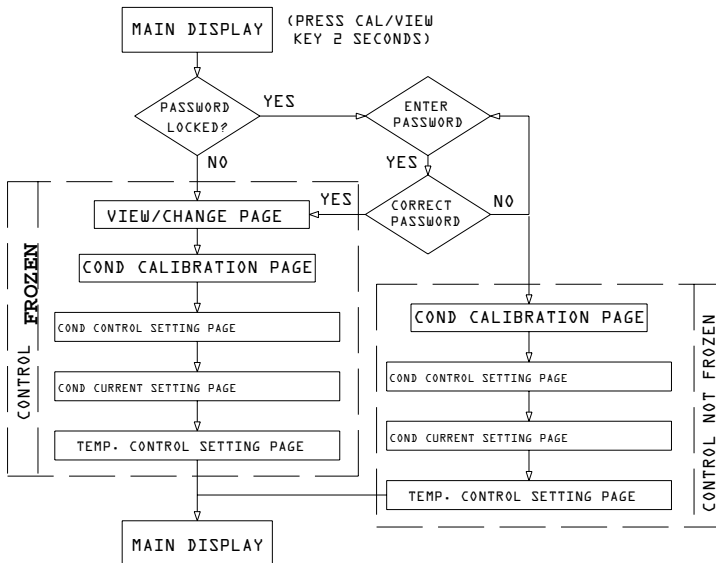

key:

1. You can change any blinking options or digit by pressing the [▲] or [▼] keys.
2. For options in digit format you need to press the [MODE/--] key to move to the next digit .
3. If you are satisfied with the selection you made you need to press the [↵] ENTER key to save the changes and move to the next option.
4. If you don't need to change the current blinking option just press the [↵] ENTER key to move to the next parameter.
5. If you need to go back to the previous parameter press the [MODE/-] key for 2 sec.

a. **PASSWORD CHECK** page



You will only see this page if the unit is password locked. To change any settings or calibration you need to unlock the system to remove the "PASSWORD LOCKED" message. You need to enter the correct 4-digit number on the "ENTER PASSWORD" input.

You can still view all the pages of **Calibration/Setting mode** if the system is password locked by just pressing the [CAL/VIEW] key on this page. If the unit is "PASSWORD LOCKED" going to **Calibration/Setting mode** will not affect the function of the relays.

CAUTION: If the unit is not locked then every time the user enters the Calibration/Setting mode the relays and analog out will be frozen.

b. **USER SETTING** page

```
USER SETTING
!! WARNING !!
RELAYS & ANALOG OUT
ARE NOW FROZEN!
PRESS CALL TO PROCEED
```

You will only see this page if the unit is not password locked. This page is just a warning, telling you that all relays are frozen, and that you can calibrate and change the settings.

NOTE: **FROZEN** MEANS ALL THE RELAYS AND THE ANALOG OUT WILL MAINTAIN THEIR LAST STATE UNTIL THE USER RETURNS TO MAIN DISPLAY MODE.

c. **CONDUCTIVITY (& TDS) CALIBRATION** page

```
COND. CALIBRATION
1. BASE CELL K: 1.00
2. RANGE: 1.0-9.999 mS
3. REF. TEMP. : 25 °C
4. TEMP. COEFF. : 2.00 %
5. TDS F: 0.500 T: 25.0 °C
6. C@25 °C: 9.900 mS
* SAVING *
```

1. **BASE CELL K** - this is the basic probe cell constant. You can choose **0.01**, **1.0** or **10**. Be careful in changing this option since it will set the actual cell constant to this value and you must calibrate the cell constant before you can accurately use the unit.

2. **RANGE** - for every basic cell constant you can choose 3 different ranges for conductivity, and an additional 3 ranges if you want your relay controls to be in TDS. Whichever you choose you can still

view the reading in TDS or conductivity but the relay control will always be what you choose here. Choosing mS or uS range will let the conductivity readings trigger the relays set point, choosing ppt/ppm will let the TDS readings trigger the relays. Conductivity and TDS have the same range limit except for the units displayed.

3. **REF. TEMP.** – If the Temperature Coefficient (TC) is not zero then the model 6308 CT will use the value here to calculate and display the compensated conductivity or TDS. The display will be the value as if the temperature is the Reference Temperature. The normal reference temperature is between 15 to 25°C but you can actually select between 10 to 29°C in this option.

4. **TEMP. COEFF.** – This will be used by conductivity or TDS if you want your display to be compensated. Setting this option to 0.00% will disable compensation. You can select between 0.00% to 4.99%.

5. **TDS F & T**- TDS Factor, this value is multiplied with the conductivity to get the TDS value. The user can directly adjust this value from **0.300 to 0.999**. **T** is the real solution temperature.

6. **C@25°C** - If the user is calibrating the Cell Constant the user must enter the conductivity value of the standard solution at 25°C.

Before calibration remember to do the following:

1. Use properly stored standard solutions and a clean calibration container.
2. Rinse the probe with de-ionized or distilled water (wipe dry) before using in standard solutions.
3. After immersing into the solution let the reading stabilize for about 1 minute and shake the probe lightly to remove any air bubbles.
4. If possible and to minimize errors perform the calibration as close as possible to the selected reference temperature.

Accurate Calibration of the Model 6308 CT

1. Clean the probe thoroughly.
2. Wait for about 30 minutes after you turned on the instrument to stabilize the circuitry before calibrating the probe.
3. Choose a calibration solution which most similar to the sample being measured.
 - a. For seawater select 50 mS conductivity standard.
 - b. For fresh water select 1 mS conductivity standard.
 - c. For brackish water select 10 mS conductivity standard.
4. Select the correct base cell constant for the probe.
5. Select the correct Range for the standard solution.
6. Input the temperature coefficient of the standard solution. Most standard salt calibration solution has a TC between 1.91% to 2.00%. If the TC is not available use the default of 2.00%.
7. During calibration the user reference temperature is **disregarded**. The reference temperature is fixed at 25°C since this temperature is the most popular reference temperature for all if not most standard solutions.
8. Immerse the probe into the solution. Do not let the probe touch any part of the container and allow at least 1 minute so the temperature reading will stabilize.
9. Shake the probe lightly to remove air bubbles from the probe.
10. Wait for the conductivity reading to be stable.
11. Press the [ENTER] key to capture the stable reading and freeze the reading. The model 6308 CT will blink the first digit to tell the user that he/she can now input the standard solution value.
12. Input the standard solution value by using the [▲] and [▼] keys (to increment/decrement the blinking digit), the [MODE/-] key (to select another digit).
13. Press the [↵] key to save the standard solution value. After saving the model 6308 CT will display a new cell constant.
14. The model 6308 CT is now ready for conductivity/TDS measurements.

Before reading the sample (unknown solution):

1. Clean the probe thoroughly.
2. Move to CONDUCTIVITY CALIBRATION page.
3. Set the RANGE to the approximate range of the solution.

4. If you want a compensated reading, input the most similar Temperature Coefficient of the sample or use the default of 2.00%. Set the Temperature coefficient to 0.00% if you want just the raw uncompensated conductivity.
5. If the TC is not 0.00% you need to select a reference temperature or set it to the default of 25°C.
6. Move the display to the normal mode.
7. Immerse the probe into the solution. Do not let the probe touch any part of the container and allow at least 1 minute so the temperature reading will stabilize.
8. Shake the probe lightly to remove air bubbles from the probe.
9. Read the display. Press the [MODE/-] key to toggle between conductivity and TDS reading.

d. CONDUCTIVITY (or TDS) CONTROL SETTING page

1. ?? RELAY1 (action) - The action

for this relay is changeable, you can choose "HI"-action or "LO" action. (In HI-action the relay will turn ON if the conductivity or TDS is greater or equal to RELAY1 value, in LO-action the relay will turn

```

COND. ONTROL SETTING
1. HI RELAY 1: 10.00mS
2. LO RELAY 2:  4.00mS
3. HYSTERESIS: 1.00 mS

#SAVING#

```

OFF if the conductivity or TDS is greater or equal to RELAY1 value, which is modified by the hysteresis value and hysteresis mode.)

(See chapter V. **CONTROLLING THE RELAYS**.)

Use [▲] and [▼] keys to select the RELAY1 action and press [↵] key to save. After you select the RELAY1 action you can now select the RELAY1 set point. Use [▲] and [▼] keys to change the blinking digit, use the [MODE/-] key to select another digit and the [↵] key to save the new set point.

2. ?? **RELAY2**(action) - The action for this relay is changeable, you can choose “**HI**”-action or “**LO**” action. (In HI-action the relay will turn **ON** if the conductivity or TDS is greater or equal to RELAY2 value, in LO-action the relay will turn **OFF** if the conductivity or TDS is greater or equal to RELAY2 value, which is modified by the hysteresis value and hysteresis mode.)

(See chapter V. **CONTROLLING THE RELAYS**.)

Use [▲] and [▼] keys to select the RELAY2 action and press [↵] key to save. After you select the RELAY2 action you can now select the RELAY2 set point. Use [▲] and [▼] keys to change the blinking digit, use the [MODE/-] key to select another digit and the [↵] key to save the new set point.

3. **HYSTERESIS (mode)** -this is the hysteresis mode for conductivity or TDS RELAY1 and RELAY2. You can choose “**CENTER**” or “**EDGE**” mode. (See chapter V. **CONTROLLING THE RELAYS**.)

4. **HYSTERESIS (value)** - this is the actual value of the hysteresis.

e. **CURRENT SETTING** page

```
CURRENT OUT SETTING
1. 4mA OUT: 0.0 mS
2. 20mA OUT: 100.0 mS

* SAVING *
```

1. **4mA OUT (offset)**- This value will be used in conjunction with 20 mA to plot the current output. (See chapter VI. **4-20 mA OUTPUT**.)

2. **20mA OUT (span)** - This value will be used in conjunction with the 4 mA value to plot the output. (See chapter VI. 4-20 mA OUTPUT.)

```
TEMP. CURRENT SETTING
1. 4mA OUT: 00.0 °C
2. 20mA OUT: 100.0 °C

*SAVING*
```

f. TEMP. CONTROL SETTING page

```
TEMP. CONTROL SETTING
1. RELAY 3 :HIGH
2. SET POINT :100.0 °C
3. HYSTERESIS :EDGE
4. HYSTERESIS :1.0 °C
5. RS 485 ID :00
6. PASSWORD SET: 0000
 * SAVING *
```

1. **RELAY 3** - the temperature has only one relay to control you need to set what action it will use, **HIGH** or **LOW** action. . (In **HIGH**-action the relay will turn **ON** if the temperature is greater or equal to RELAY3 value, in **LOW**-action the relay will

turn **OFF** if the temperature is less than or equal to RELAY3 value, which is modified by the hysteresis value

2. **ce** and hysteresis mode.)

(See chapter V. **CONTROLLING THE RELAYS** .)

2. **SET POINT (For positive temperature only)**- this is the user changeable value for the Temperature relay.

3. **HYSTERESIS (mode)** -this is the hysteresis mode for TEMPERATURE relay. You can choose "CENTER" or "EDGE". (See chapter V. **CONTROLLING THE RELAYS**.)
4. **HYSTERESIS (value)**- this is the actual value of the hysteresis. You can change this value from 0.0 to 19. 9°C. (See chapter V. **CONTROLLING THE RELAYS**.)
5. **RS 485 ID** - this is the unique ID/Address for the unit. If you are connecting multiple model 6308 CT or other Jenco models for logging purposes then this ID/Address must be unique for each connected unit. This ID/Address is the same address that must be used by the PC program to communicate with this unit.
5. **PASSWORD SET** - this is your security code if the unit is locked the value here will not be available. You need to input the correct code in the PASSWORD CHECK page.

CAUTION: The user is responsible in remembering their password number otherwise you would no be able to calibrate or change the settings.

V. CONTROLLING THE RELAYS

A. ISOLATION VOLTAGE

The maximum isolation voltage of the relay output contacts is 1500 VDC. The voltage differential between the relay output contacts and the load should not exceed 1500 VDC.

B. OUTPUT LOAD

The current through the relay output contacts should not exceed 5 Amp at 115 VAC and 2.5 Amp at 230 VAC in order not to cause permanent damage to the relay contacts. This rating is specified for **resistive** loads only.

C. RELAY ACTION, RELAY SETPOINT, HYSTERESIS MODE & HYSTERESIS VALUE

If the relay action is set to HI and the hysteresis mode is CENTER, the relay will turn **ON** at $[(\text{RELAY SETPOINT}) + (0.5 * \text{hysteresis value})]$, and will turn **OFF** at $[(\text{RELAY SETPOINT}) - (0.5 * \text{hysteresis value})]$.

If the relay action is set to LO and the hysteresis mode is CENTER, the relay will turn **OFF** at $[(\text{RELAY SETPOINT}) + (0.5 * \text{hysteresis value})]$, and will turn **ON** at $[(\text{RELAY SETPOINT}) - (0.5 * \text{hysteresis value})]$.

Relay Action	Hysteresis mode	Effective RELAY-ON Setpoint	Effective RELAY-OFF Setpoint
HIGH	CENTER	S.P.+ 1/2(H.V.)	S.P. -1/2 (H.V.)
LOW	CENTER	S.P.-1/2 (H.V.)	S.P.+1/2 (H.V.)

S.P. = Relay Set point

H.V.= Hysteresis value (DeadBand)

D. CONDUCTIVITY/TDS RELAYS

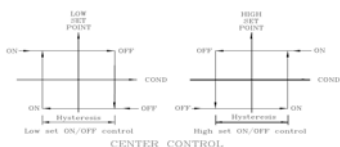

Fig. 1

There are two independent Relay channels for the TDS or conductivity display which has independent set point and HIGH or LOW action setting (see **fig. 1**). The hysteresis mode (center or edge,

see **figure 1.**) and hysteresis value will be used by both relays.

The action of the relays is dependent on set point, relay action (HIGH or LOW), hysteresis mode (Edge or Center) , hysteresis value and the current conductivity or TDS display. (see **fig. 1**).

E. TEMPERATURE RELAY

One relay channel is available for temperature display which has independent set point and HIGH or LOW action (see fig. 1) setting, hysteresis mode (center or edge) and hysteresis value.

The action of the Temperature relay is dependent on set point, relay action (HIGH or LOW), hysteresis mode (Center or Edge) , hysteresis value and the current Temperature display. (See fig. 1).

VI. 4 - 20 mA OUTPUT

A. ISOLATION VOLTAGE

The maximum isolation voltage of the 4-20 mA output is 500 VDC. The voltage differential between the 4-20 mA output and the load should not exceed 500 VDC.

B. OUTPUT LOAD

The maximum load is 500 Ω . Output current inaccuracies may occur for load impedance in excess 500 Ω .

C. Conductivity or TDS Linear Output

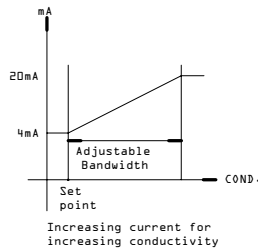
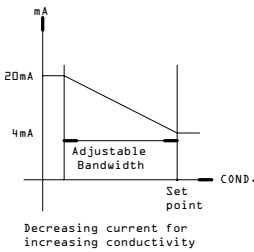

← Conductivity / TDS output

Fig. 2

The linear analog output will be dependent on the 4 mA setting, 20 mA setting and the current conductivity or TDS display.

The analog output is based on the following equation :

$$mA_{(c)} = 4mA + (16mA) * (D_{(c)} - C(4)) / (C(20) - C(4))$$

Where :

$mA_{(c)}$ = analog output

$D_{(c)}$ = current conductivity or TDS display

$C(4)$ = conductivity or TDS user setting for 4 mA

$C(20)$ = conductivity or TDS user setting for 20 mA.

Note :

1. The absolute difference of the 4mA and 20mA settings must be greater or equal to 10 LSD(Least Significant Digit) of the user range.
2. If the absolute difference is smaller than 10 LSD the current output will display " ERROR".

VII. RS485 INTERFACE OPERATION

A. INTRODUCTION

This section assumes you are familiar with the basics of data communication, the RS485 interface, a rudimentary knowledge and a copy of the more popular Windows® 95+ computer languages capable of using a PC RS485 card or RS232-RS485 converter (**third party vendor**) module .

A simple program must be written in order to send your command and receive data from the meter.

A sample source program in DELPHI® 5.0 or VISUAL BASIC® 6.0 is included in the accompanying disk.

B. PREPARING THE METER

This meter comes equipped with a 2-wire RS485 interface. Just connect each terminal to the respective RS485 terminal on your PC. (If the DEMO program is not working try reversing the connections of the terminals.) After you have connected correctly the meter (or multiple meters with unique ID number) and turned on both the

meter(s) and the computer, you are now ready to program a simple routine to read data from the instrument.

Read the file "6308CT.TXT" in the accompanying disk to jump-start you in using the meter with your RS485 enabled PC.

VIII. ERROR DISPLAYS AND TROUBLESHOOTING

LCD display	ATC display	mode	Possible cause(s) [Action(s)]
"TERR"	"OVER"	Conductivity, TDS or Cell Calibration	a. Temperature > 120.0°C. [Bring solution to a lower temperature.] [Replace temperature probe.] b. No temperature sensor.. [Use a temperature probe.]
"TERR"	"UNDR"	Conductivity, TDS or Cell Calibration	Temperature < -10.0°C. [Bring solution to a higher temperature.]
"OVER"	-10.0~ 120.0°C	Conductivity, TDS or Cell Calibration	Reading over user specified range . [Change range to higher level]
"LERR"	-10.0 ~ 120.0°C	Conductivity, TDS or Cell Calibration	Compensated Calibration exceeds temperature limit. [Increase or decrease the solution temperature]
EEPROM : BAD		Power-on	Unit has failed its EEPROM test. [Turn instrument OFF and back to ON again.] [Return for service. (see Warranty)]

ROM BAD		Power-on	Unit has failed its ROM test. [Turn instrument OFF and back to ON again.] [Return for service. (see Warranty)]
RAM BAD		Power-on	Unit has failed its RAM test. [Turn instrument OFF and back to ON again.] [Return for service. (see Warranty)]

IX. SPECIFICATIONS

Conductivity

Range	Basic Cell K	Resolution	Accuracy
0 to 9.999 uS	0.01	0.001 uS	0.5% ± 1 LSD
1.0 to 99.99 uS	0.01	0.01 uS	0.5% ± 1 LSD
10 to 300.0 uS	0.01	0.1 uS	0.5% ± 1 LSD
10 to 999.9 uS	1.00	0.1 uS	0.5% ± 1 LSD
0.1 to 9.999 mS	1.00	0.001 mS	0.5% ± 1 LSD
1.0 to 30.00 mS	1.00	0.01 mS	0.5% ± 1 LSD
0.1 to 9.999 mS	10.0	0.001 mS	0.5% ± 1 LSD
1.0 to 99.99 mS	10.0	0.01 mS	0.5% ± 1 LSD
10 to 300.0 mS	10.0	0.1 mS	0.5% ± 1 LSD

TDS

Range	Basic Cell K	Resolution	Accuracy
0 to 9.999 ppm	0.01	0.001 ppm	0.5% ± 1 LSD
1.0 to 99.99 ppm	0.01	0.01 ppm	0.5% ± 1 LSD
10 to 300.0 ppm	0.01	0.1 ppm	0.5% ± 1 LSD
10 to 999.9 ppm	1.00	0.1 ppm	0.5% ± 1 LSD

0.1 to 9.999 ppt	1.00	0.001 ppt	0.5% ± 1 LSD
1.0 to 30.00 ppt	1.00	0.01 ppt	0.5% ± 1 LSD
0 to 9.999 ppt	10.0	0.001 ppt	0.5% ± 1 LSD
1.0 to 99.99 ppt	10.0	0.01 ppt	0.5% ± 1 LSD
10 to 300.0 ppt	10.0	0.1 ppt	0.5% ± 1 LSD

Temperature

Range	Resolution	Accuracy
-10.0 to 120.0 °C	0.1 °C	± 0.3 °C

Conductivity / TDS

TDS Factor Range	0.300 to 0.999 (user selectable)
Reference Temperature	10°C to 29°C (user selectable)
Temperature Coefficient	0.00 to 4.99% (user selectable)
Temperature Compensation	Automatic

Temperature

Temperature sensor	Thermistor, 10 k Ω at 25°C
---------------------------	-----------------------------------

4-20mA Output

Current output range	4 to 20 mA (isolated)
Current output scale	user programmable
Maximum load	500 Ω
Accuracy	± 0.1 mA
Isolation voltage	500VDC

Controller

Control type	ON/OFF control
Relay output	5A at 115VAC or 2.5A at 220VAC

GENERAL

Keys	Audio feedback in all keys
Security protect	4-digit password
Communication	RS485
Power:	115VAC or 230VAC 50/60Hz
Power consumption	6 watts
Fuse	315mA/250V fast acting glass tube
Ambient temperature range	0.0 to 50.0 °C
Display:	128x64 graphic LCD w/ backlight
Case	IPT67 ¼ DIN case, depth 155mm
Weight	950 g

X. WARRANTY

Jenco Instruments, Ltd. warrants this product to be free from significant deviations in material and workmanship for a period of 1 year from date of purchase. If repair or adjustment is necessary and has not been the result of abuse or misuse, within the year period, please return-freight-prepaid and the correction of the defect will be made free of charge. If you purchased the item from our Jenco distributors and it is under warranty, please contact them to notify us of the situation. Jenco Service Department alone will determine if the product problem is due to deviations or customer misuse.

Out-of-warranty products will be repaired on a charge basis.

RETURN OF ITEMS

Authorization must be obtained from one of our representatives before returning items for any reason. When applying for authorization, have the model and serial number handy, including

data regarding the reason for return. For your protection, items must be carefully packed to prevent damage in shipment and insured against possible damage or loss. Jenco will not be responsible for damage resulting from careless or insufficient packing. A fee will be charged on all authorized returns.

NOTE: Jenco reserves the right to make improvements in design, construction and appearance of our products without notice.

(Manual Version: 07312003)

(For firmware 6308CT version 3.00)